



**3-3.5 ton
AC ELECTRIC
FORKLIFT**

S SERIES

HELI

CHINESE EXPORT BRAND

Recommended
By China Chamber of Commerce for Import and Export of Machinery
And Electric Products

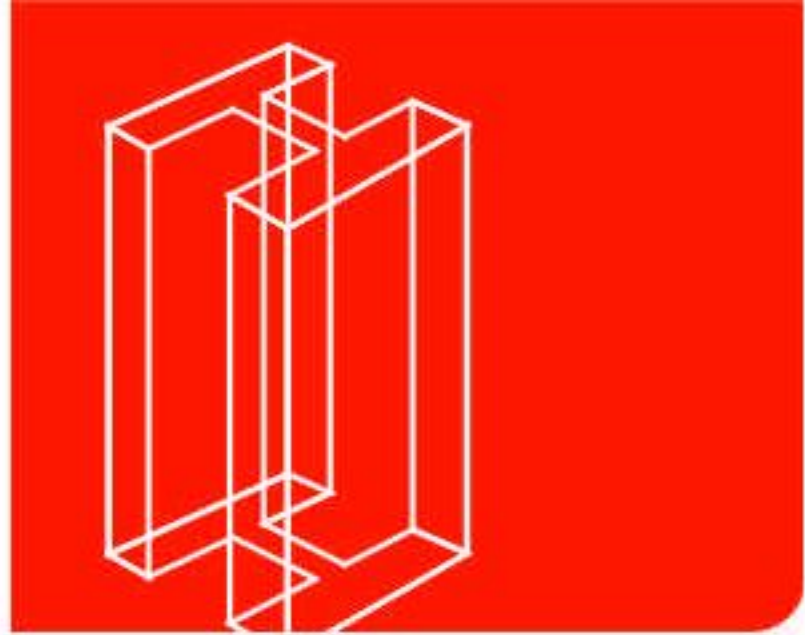

AC ELECTRIC FORKLIFT 3-3.5 ton

HELI

Newly designed wide-view mast



The newly designed wide-view mast enlarges operators' view effectively and lessens the blind area to provide a clearer vision.

↑ 7%
THE MAST VIEW INCREASES

Excellent steering system



The Steering system with new technologies not only provides a smoother swerve and faster positioning & steering, but also effectively lowers down the noise.

- ✓ New integrated load-sensing steering
- ✓ Power Steering
- ✓ New low-noise gear pump with differential tooth technology

AC drive motor



- ✓ Large ratio gearbox
- ✓ Motor maintenance
- ✓ Maintain more efficient
- ✓ Renewable energy technologies

The wonderful combination of high-power AC motor and the new style gearbox by independent R&D fully enhance the performance of acceleration, driving, loading /unloading and grade ability.

↑ 50 %
GRADIENT PERFORMANCE INCREASES

↑ 25 %
THE MAXIMUM TRAVEL SPEED INCREASES

High efficiency loading/unloading performance

The innovative design and configuration of hydraulic system improve the working efficiency largely and provide a very efficient loading/unloading.

↑ 20%
THE MAXIMUM UNLOADED LIFTING SPEED INCREASES

↑ 12%
THE MAXIMUM LOADED LIFTING SPEED INCREASES



- ✓ New low-speed & high-torque lifting motor
- ✓ MOSFET lifting controller
- ✓ New dynamic load sensing technology in hydraulic system
- ✓ Optional AC lifting system greatly enhances the loading/unloading performance.

Enough operation space

The new optimization layout widens the operator space for ensuring more comfortable and convenient operation.

↑ 12%
THE OPERATING SPACE INCREASES

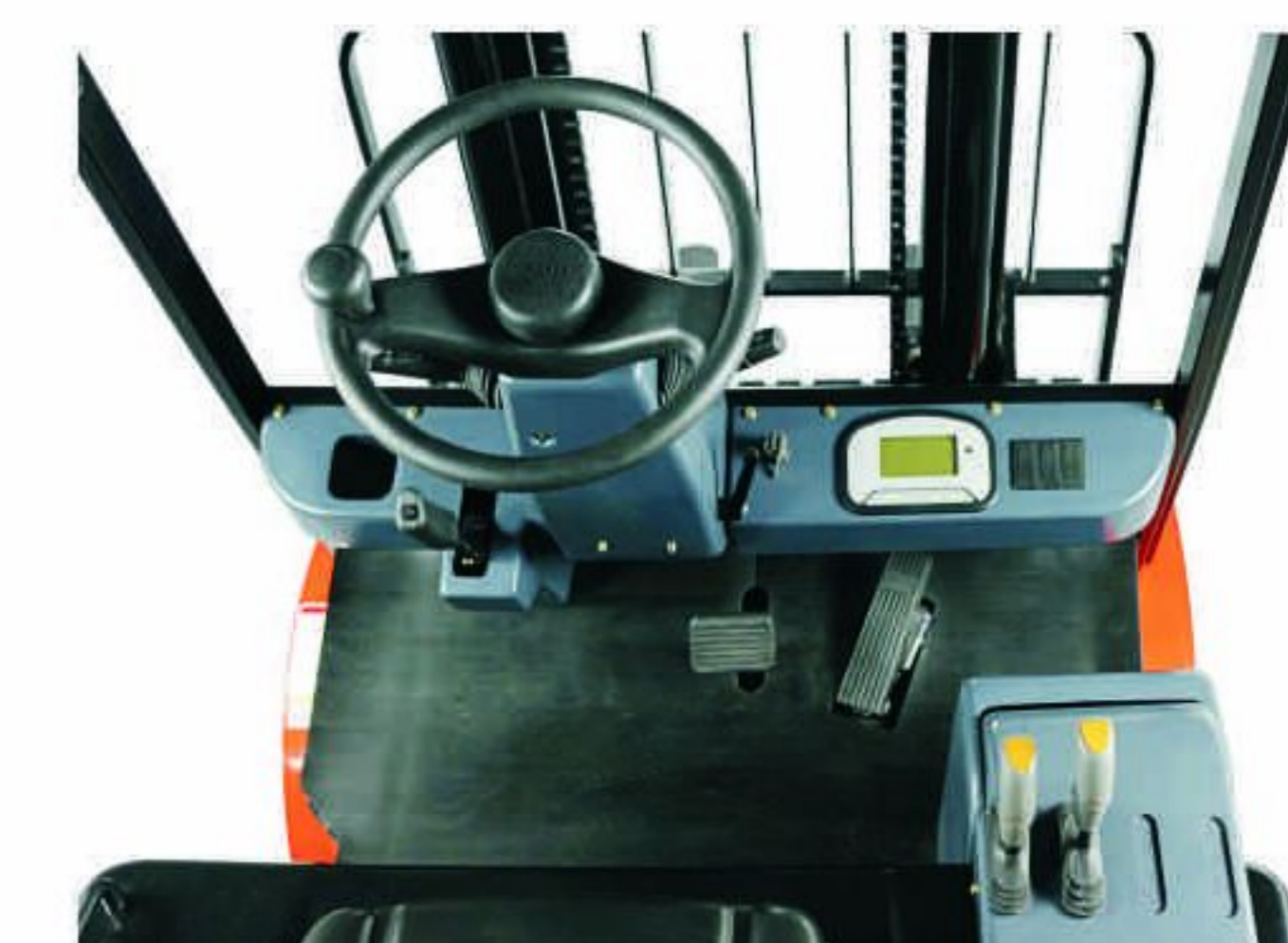

More intelligent performance

The truck equipped with more intelligence functions not only ensures the safety performance, but also improves the efficiency and reduces energy consumption.

- ✓ Standard CAN BUS
- ✓ Self-braking on ramp
- ✓ Preventing abnormality operating
- ✓ AC traction controller
- ✓ Emergency power shut-down
- ✓ Electric controller self-protecting
- ✓ Presence of driver sensing system
- ✓ Speed selection function (normal/cutback)



ZAPI CONTROLLER



CURTIS CONTROLLER

WIDE VIEW MAST

Mast model	Max. Fork height (mm)	Load Capacity (Load centre 500mm) (kg)		Overall Height (mm)		Tilt Angle (F-B)
		CPD30	CPD35	CPD30	CPD35	
M200	2000	3000	3500	1565	1680	6/10
M250	2500	3000	3500	1815	1930	6/10
M300	3000	3000	3500	2075	2180	6/10
M330	3300	3000	3500	2215	2330	6/10
M350	3500	3000	3500	2315	2430	6/10
M370	3700	3000	3400	2415	2530	6-6 *6-10
M400	4000	2950	3350	2615	2730	6-6 *6-10
M425	4250	2850	3250	2740	2855	6-6 *6-10
M450	4500	2750	3100	2865	2980	6-6 *6-10
M500	5000	2400 *2550	2650 *2800	3115	3230	6-6 *6-6
M550	5500	2250 *2450	2500 *2600	3415	3530	*3-6
M600	6000	1500 *2200	1550 *2400	3665	3780	*3-6

WIDE VIEW FULL FREE 2-STAGE MAST

Mast model	Max. fork height (mm)	Load Capacity (Load centre 500mm) (kg)		Overall Height (mm)		Free lift (With STD backrest) (mm)		Tilt Angle (F-B)
		CPD30	CPD35	CPD30	CPD35	CPD30	CPD35	
ZM200	2000	3000	3500	1570	1680	344	500	6/10
ZM250	2500	3000	3500	1820	1930	594	750	6/10
ZM300	3000	3000	3500	2070	2180	844	1000	6/10
ZM330	3300	3000	3500	2220	2330	994	1150	6/10
Zm350	3500	3000	3500	2320	2430	1094	1250	6/10
ZM370	3700	3000	3400	2420	2530	1194	1350	6-6 *6-10
ZM400	4000	2950	3350	2620	2730	1394	1550	6-6 *6-10
ZM425	4250	2850	3250	2745	2855	1519	1675	6-6 *6-10
ZM450	4500	2750	3100	2870	2980	1644	1800	6-6 *6-10
ZM500	5000	2400 *2550	2650 *2800	3120	3230	1894	2050	6-6 *6-6
ZM550	5500	2250 *2450	2500 *2600	3420	3530	2194	2350	*3-6
ZM600	6000	1500 *2200	1550 *2400	3670	3780	2444	2600	*3-6

WIDE VIEW FULL FREE 3-STAGE MAST

Mast model	Max. Fork height (mm)	Load Capacity (Load centre 500mm) (kg)		Overall Height (mm)		Free lift (With STD backrest) (mm)		Tilt Angle (F-B)
		CPD30	CPD35	CPD30	CPD35	CPD30	CPD35	
ZSM360	3600	3000	3400	1946	1946	670	670	6/6
ZSM400	4000	2900	3250	2065	2065	795	795	6/6
ZSM435	4350	2750	3150	2190	2190	920	920	6/6
ZSM450	4500	2700	3000	2240	2240	970	970	6/6
ZSM480	4800	2600	2800	2340	2340	1070	1070	6/6
ZSM500	5000	2400 *2500	2650	2440	2440	1170	1170	6/6
ZSM540	5400	2250 *2450	2500	2565	2565	1295	1295	3/6
ZSM600	6000	1550 *2150	1550 *2300	2790	2790	1520	1520	3/6

NOTE : (1)* Rated capacity with front dual tires ;

(2)CPD30:The free height of full free 2-stage mast without backrest increase 490mm ;

(3)CPD35:The free height of full free 2-stage mast without backrest increase 412mm ;

(4)The free lift height of full free 3-stage mast without backrest increase 520mm.



Manufacturers Data and Design Characteristics

Characteristics				
1.01	Manufacture's Name		HELI	
1.02	Model Designation		CPD30	CPD35
1.03	Configuration Number		G1/G2	G1/G2
1.04	Load Capacity	Q (kg)	3000	3500
1.05	Load Center	c (mm)	500	500
1.06	Power Type		Battery	Battery
1.07	Operator Type		Seated	Seated
1.08	Wheelbase	y (mm)	1680	1680
Wheels & Tyres				
2.01	Tyre Type		Pneumatic	Superelastic
2.02	Tyres Number (Front/Rear)		2/2	2/2
2.03	Tread(centre of tyre),front	b10 (mm)	1055	1055
2.04	Tread(centre of tyre),rear	b11 (mm)	980	980
2.05	Tyre Size, Front		28×9-15-12PR	28×9-15
2.06	Tyre Size, Rear		18×7-8-14PR	18×7-8
Dimensions				
3.01	Load Distance	x (mm)	485	490
3.02	Mast Tilt Angle,F/R	α / β (°)	6/10	6/10
3.03	Height with Mast Lowered	h1(mm)	2075	2180
3.04	Free Lift	h2(mm)	145	150
3.05	Standard Lift Height	h3(mm)	3000	3000
3.06	Height with Mast Extended	h4(mm)	4182	4117
3.07	Overhead Guard Height	h6(mm)	2215	2215
3.08	Fork Size T×W×L	s/e/L(mm)	45×125×1070	50×125×1070
3.09	Fork Carriage to DIN 15173 A/B		2A	2A
3.10	Length to fork face	L2(mm)	2485	2550
3.11	Overall Width	b1(mm)	1225	1225
3.12	Outside Turning Radius	Wa(mm)	2210	2270
3.13	Ground Clearance at mast ,Loaded	m1(mm)	135	135
3.14	Ground Clearance at centre of wheelbase ,Loaded	m2(mm)	150	150
3.15	Right Stack Aisle width (Pallet size 1000x1000mm, clearance:200mm)	Ast(mm)	3895	3960
3.16	Right Stack Aisle width (Pallet size 1200x1200mm, clearance:200mm)	Ast(mm)	4095	4160
Performances				
4.01	Travel Speed,with/without load	km/h	15.0/15.5	14.5/15.0
4.02	Lifting Speed,with/without load	m/s	0.28/0.45	0.25/0.44
4.03	Lowering Speed	m/s	0.5	0.5
4.04	Gradient performance with load	%	15	12
4.05	Max. draw bar pull with load	N	15600	17500
4.06	Acceleration time (10 metres) W/O load	s	5.0/4.7	5.2/4.9
Weight				
5.01	Total Approximate Weight(W/O battery)	kg	4810/3230	5500/3920
5.02	Axle Loading*: Unloaded,Front/Rear	kg	2320/2490	2640/2860
5.03	Axle Loading*: Loaded,Front/Rear	kg	7055/755	8145/855
Battery				
6.01	Battery Voltage/rated capacity(5h)	V/Ah	80/480	80/480
6.02	battery weight	kg	1580	1580
6.03	Battery to DIN 43531/35/36/A/B/C		43536A	43536A
Motor & Controller				
7.01	Drive Motor - 60 Min. Rating	kW	16.6	16.6
7.02	Pump Motor - 15 Min. Rating	kW	13	13
7.03	Drive Motor Control Method		MOSFET/AC	MOSFET/AC
7.04	Pump Motor Control Method		MOSFET/DC	MOSFET/DC
7.05	Service Brake/Parking Brake		Hydraulic/Mechanical	Hydraulic/Mechanical
7.06	Relief Pressure	Mpa	21	21

9 SERIES



AC ELECTRIC
FORKLIFT

3-3.5 ton



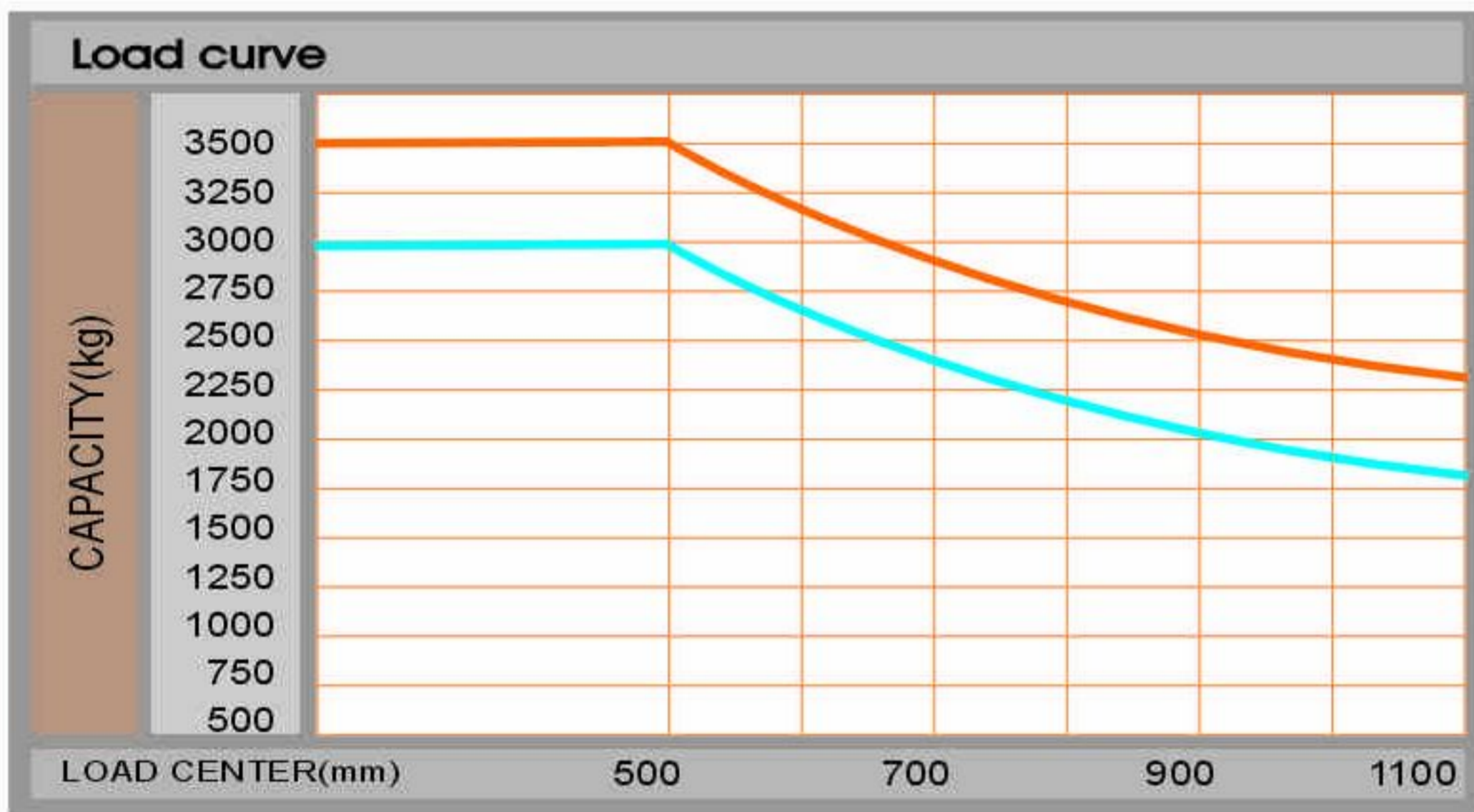
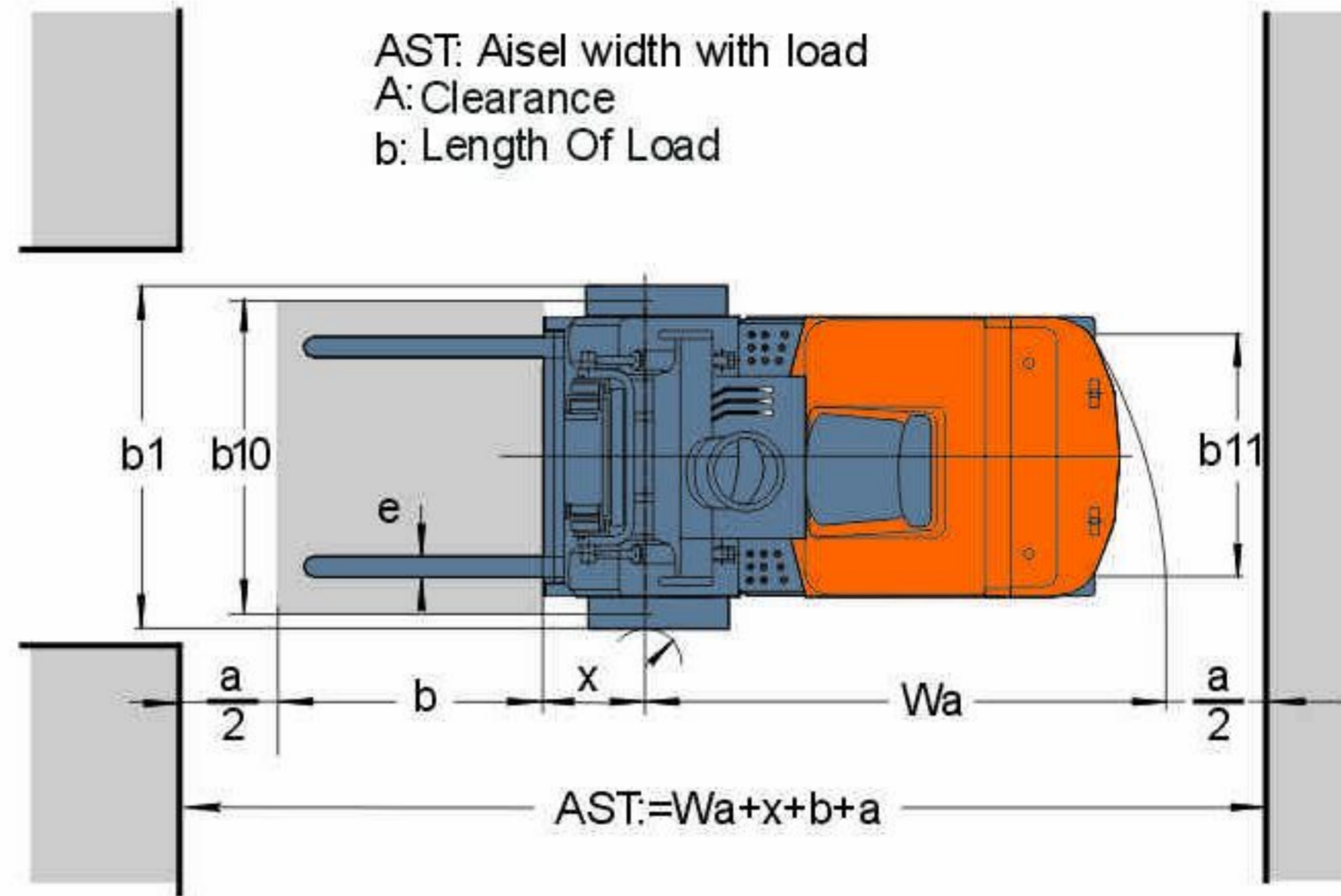
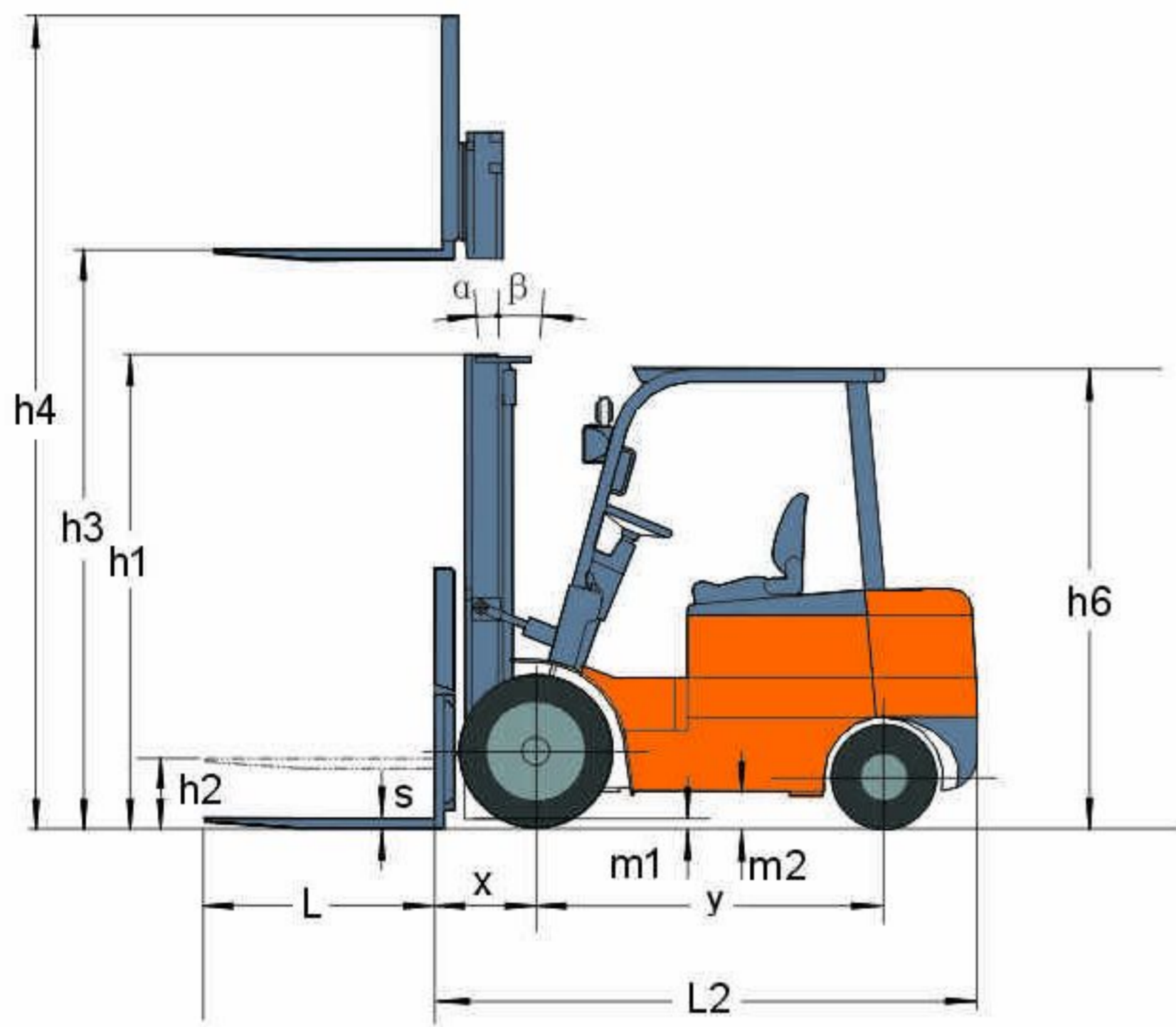

3.0t 3.5t

Vertical axle stands for load capacity while horizontal axle stands for load center. Load center is the distance counted from the front of the fork. The base point of the standard load is the center point of the cubic with the same 1000mm dimension in length, width and height. The load capacity should be down, if mask tilts forward, using non-standard forks or loading goods with extra width. Please notice the different load capacity between different load centers according to load chart.



Renewable energy technologies

With the use of the excellent load-sensing steering system and AC controlling renewable energy technologies, the forklift is more energy-saving and the working hour of the battery is extended by 15%.

↑ 15%

THE PERFORMANCE OF BATTERY INCREASES

The reliable special instrument gives a complete display of the vital information, like operation status, fault detection, etc. It ensures the operator predominate the vehicle status more intuitive and convenient.

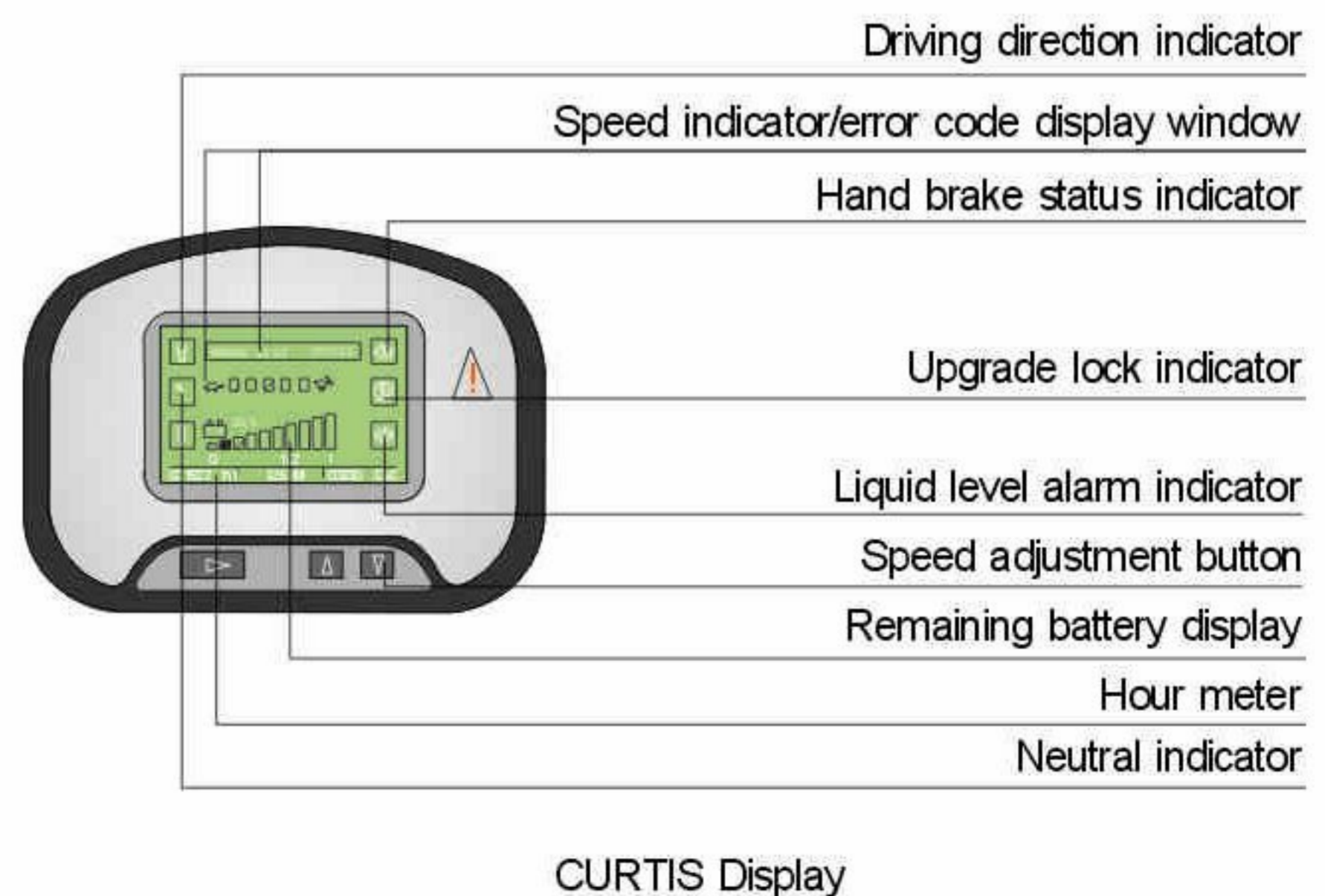
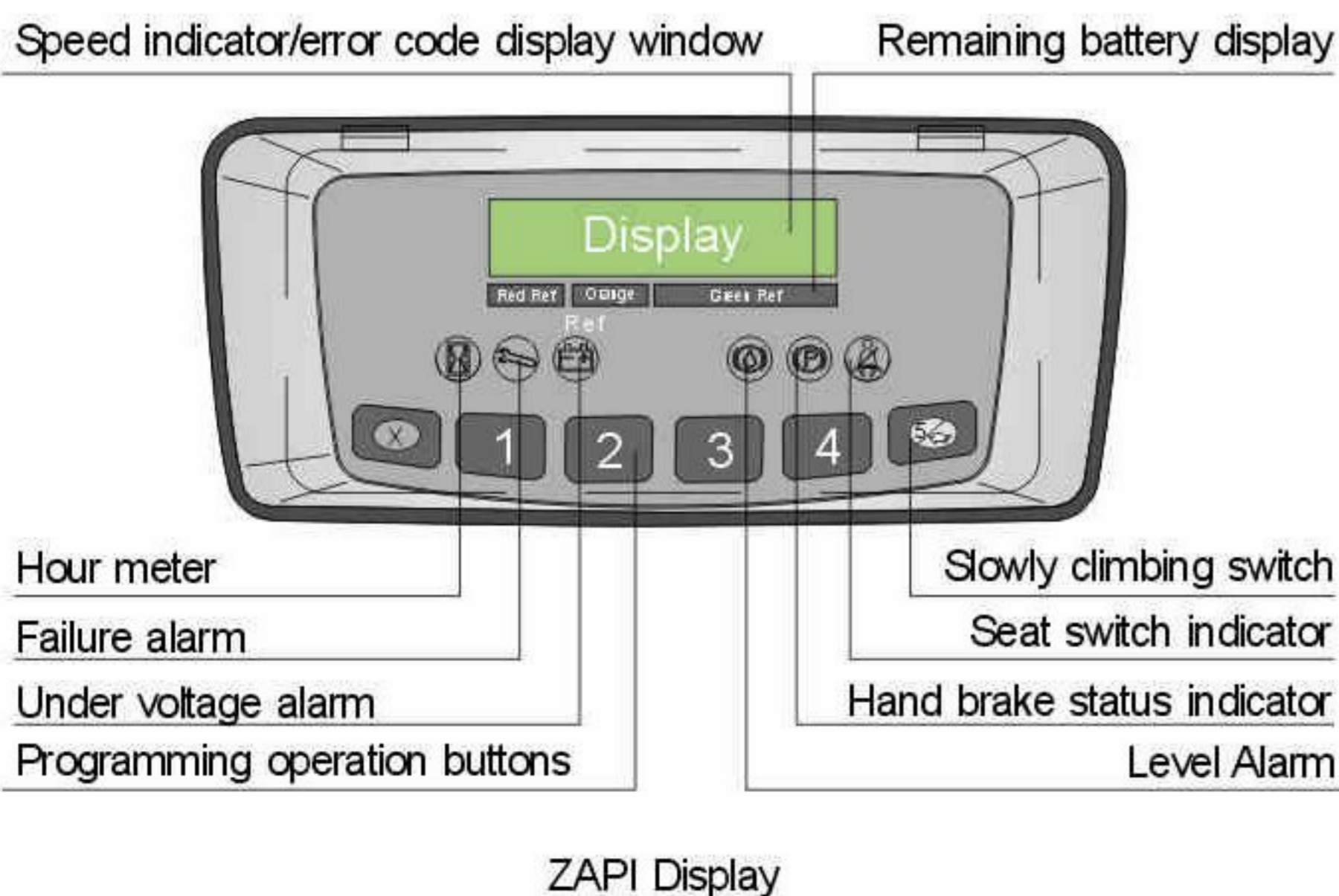

HELI

3 SERIES



3-3.5 ton
AC ELECTRIC
FORKLIFT

STANDARD EQUIPMENT

Mask with wide view
Standard fork
II (III) fork holder
Fork bracket
Control valve
Battery group
Standard seat
Overhead guide
Overhead guide raincoat
LCD compound displayer
Pneumatic tyres
Traction bar
Relevant tools

OPTIONS

Boom
Cab
Load hawk
Load bar
Hinged fork
Back view mirror
Side shifter
Paper roll clamp
Alarm lamp
Solid tyre
Rear work light
Steel protection net
Multi function barrel clamp
Load stabilizer
Widened fork holder
Lengthened fork
Load pusher
Sleeve on fork
Rotating flat clamp
By-tyres protector
Accessory hydraulic component
Tilt/Steering cylinder protection sleeve
Colored tyre)white/green(
Wide view double/triplex mast with full free length
Customer referred color

Kindy, Zhang
Anhui HELI forklifts
15 Wangjiang West Road, Hefei, Anhui, China
Tel: 0086-551-3639068 / 3648005*6805
Fax: 0086-551-3639966
Mobile: 0086 13866750039
SKYPE ID: kindy428
MSN ID: kindy428@hotmail.com
Homepage: www.helichina.com
E-mail: kindy428@gmail.com / heli.kindy@gmail.com / zjd@heliforklift.com



TOP1 FORKLIFT MANUFACTURING AND SALE
IN CHINA CONTINUOUSLY FOR 20 YEARS